



Features

- Constant Voltage + Constant Current mode output(12/24V)
- Constant power mode output(56V)
- Wide input range 120-305VAC with PFC function
- Compliance with BS EN/EN61347/EN60335-1 regulations
- Class II power unit
- Slim and Compact housing Design
- No load power consumption <0.5W(12/24V)
- 5 years warranty

Applications

- Strip lighting
- Decoration lighting
- Cabinet lighting
- Signage and display
- Cove lighting
- Household device lighting

GTIN CODE

MW Search: <https://www.meanwell.com/serviceGTIN.aspx>

Description

SLD-150 series is a 150W AC/DC LED driver featuring with dual modes for constant voltage and constant current applications. SLD-150 operates from 120~305VAC and offers models with different rated voltage ranging between 12V and 56V. The 12V and 24V are suitable for constant voltage LED strip or household device and 56V is support for constant current application. Thanks to the high efficiency up to 93%, with the fanless design, the entire series is able to operate for -25°C ~ +85°C case temperature under free air convection. SLD-150 design with low profile and slim housing which is good for signage and decoration lighting applications.

Model Encoding

SLD - 150 - 24

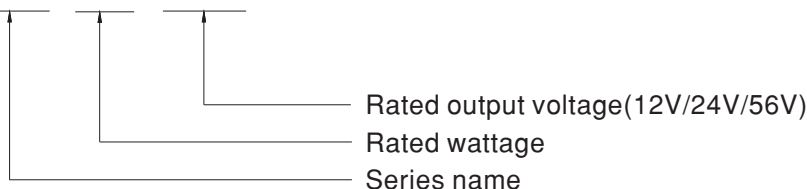

SPECIFICATION:(Constant Voltage + Constant Current mode)

MODEL	SLD-150-12	SLD-150-24		
OUTPUT	DC VOLTAGE (default)	12V	24V	
	CONSTANT CURRENT REGION <small>Note.2</small>	8.4~12V	16.8~24V	
	RATED CURRENT	12A	6.3A	
	RATED POWER <small>Note.5</small>	144W	151.2W	
	RIPPLE & NOISE (max.) <small>Note.3</small>	180mVp-p	240mVp-p	
	VOLTAGE TOLERANCE <small>Note.4</small>	±4.0%	±3.0%	
	LINE REGULATION	±0.5%	±0.5%	
	LOAD REGULATION	±1%	±1%	
	SETUP, RISE TIME <small>Note.6</small>	500ms, 80ms 230VAC		
HOLD UP TIME (Typ.)	10ms/230VAC			
INPUT	VOLTAGE RANGE <small>Note.5</small>	120~ 305VAC 170~ 431VDC (Please refer to "STATIC CHARACTERISTIC" section)		
	FREQUENCY RANGE	47 ~ 63Hz		
	POWER FACTOR	PF ≥ 0.95/230VAC, PF ≥ 0.92/277VAC@full load (Please refer to "POWER FACTOR (PF) CHARACTERISTIC" section)		
	TOTAL HARMONIC DISTORTION	THD < 10% (@load ≥ 60%/230VAC; @load ≥ 75%/277VAC) (Please refer to "TOTAL HARMONIC DISTORTION(THD)" section)		
	EFFICIENCY (Typ.)	92%	93%	
	AC CURRENT	1A / 230VAC 0.8A/277VAC		
	INRUSH CURRENT(Typ.)	COLD START 65A(twidth=500μs measured at 50% Ipeak) at 230VAC; Per NEMA 410		
	MAX. No. of PSUs on 16A CIRCUIT BREAKER	5 units (circuit breaker of type B) / 8 units (circuit breaker of type C) at 230VAC		
	LEAKAGE CURRENT	<0.35mA / 294VAC		
	NO LOAD POWER CONSUMPTION	<0.5W		
PROTECTION	OVER CURRENT	95 ~ 108% Constant current limiting, continous increase of load will be hiccup protection, recovers automatically after fault condition is removed		
	SHORT CIRCUIT	Hiccup mode, recovers automatically after fault condition is removed		
	OVER VOLTAGE	14 ~ 17V	28 ~ 34V	
	OVER TEMPERATURE	Shut down output voltage, re-power on to recovery		
ENVIRONMENT	WORKING TEMP.	Tcase=-25 ~ +85°C (Please refer to " OUTPUT LOAD vs TEMPERATURE" section)		
	MAX. CASE TEMP.	Tcase=+85°C		
	WORKING HUMIDITY	20 ~ 95% RH non-condensing		
	STORAGE TEMP.	-40 ~ +80°C		
	TEMP. COEFFICIENT	±0.03%/°C (0 ~ 50°C)		
	VIBRATION	10 ~ 500Hz, 2G 12min./1cycle, period for 72min. each along X, Y, Z axes		
SAFETY & EMC	SAFETY STANDARDS <small>Note.8</small>	ENEC BS EN/EN61347-1, BS EN/EN61347-2-13 independent, BS EN/EN62384, EN60335-1 EAC TP TC 004, GB19510.1, GB19510.14 approved		
	WITHSTAND VOLTAGE	I/P-O/P:3.86KVAC		
	ISOLATION RESISTANCE	I/P-O/P:100M Ohms / 500VDC / 25°C / 70% RH		
	EMC EMISSION <small>Note.8</small>	Parameter	Standard	Test Level/Note
		Conducted	BS EN/EN55015(CISPR15)/EN55014, GB/T17743	-----
		Radiated	BS EN/EN55015(CISPR15)/EN55014, GB/T17743	-----
		Harmonic Current	BS EN/EN61000-3-2, GB/T17625.1	Class C @load ≥ 60%
	Voltage Flicker	BS EN/EN61000-3-3	-----	
	EMC IMMUNITY	BS EN/EN61547		
		Parameter	Standard	Test Level/Note
		ESD	BS EN/EN61000-4-2	Level 3, 8KV air ; Level 2, 4KV contact
Radiated		BS EN/EN61000-4-3	Level 2	
EFT/Burst		BS EN/EN61000-4-4	Level 2	
Surge		BS EN/EN61000-4-5	1KV/Line-Line	
Conducted		BS EN/EN61000-4-6	Level 2	
Magnetic Field		BS EN/EN61000-4-8	Level 2	
Voltage Dips and Interruptions	BS EN/EN61000-4-11	>95% dip 0.5 periods, 30% dip 25 periods, >95% interruptions 250 periods		
OTHERS	MTBF	2883.5K hrs min. Telcordia SR-332 (Bellcore) ; 298.8K hrs min. MIL-HDBK-217F (25°C)		
	DIMENSION	330*35*22mm (L*W*H)		
	PACKING	0.31Kg; 48pcs / 15.9Kg / 0.79CUFT		
NOTE	1. All parameters NOT specially mentioned are measured at 230VAC input, rated current and 25°C of ambient temperature. 2. Please refer to "DRIVING METHODS OF LED MODULE". 3. Ripple & noise are measured at 20MHz of bandwidth by using a 12" twisted pair-wire terminated with a 0.1uf & 47uf parallel capacitor. 4. Tolerance : includes set up tolerance, line regulation and load regulation. 5. De-rating is needed under low input voltages. Please refer to "STATIC CHARACTERISTIC" sections for details. 6. Length of set up time is measured at first cold start. Turning ON/OFF the driver may lead to increase of the set up time. 7. The driver is considered as a component that will be operated in combination with final equipment. Since EMC performance will be affected by the complete installation, the final equipment manufacturers must re-qualify EMC Directive on the complete installation again. 8. This series meets the typical life expectancy of 50000 hours of operation when Tcase, particularly (Tc) point (or TMP, per DLC), is about 75°C or less. 9. Please refer to the warranty statement on MEAN WELL's website at http://www.meanwell.com 10. The ambient temperature derating of 3.5°C/1000m with fanless models and of 5°C/1000m with fan models for operating altitude higher than 2000m(6500ft). 11. RCM is on a voluntary basis. An Non IC classification Independent LED control gear is not suitable for residential installations but recommend to be used for commercial decoration / sign board / luminaire lighting purpose. ※ Product Liability Disclaimer : For detailed information, please refer to https://www.meanwell.com/serviceDisclaimer.aspx			

SPECIFICATION: (Constant Power mode)

MODEL		SLD-150-56		
OUTPUT	RATED CURRENT(Default)	4000mA (The maximum rated power is 151.2W)		
	RATED POWER <small>Note.2/3</small>	151.2W		
	CONSTANT CURRENT REGION <small>Note.10</small>	24~56V(Factory default 48V)		
	FULL POWER CURRENT RANGE	2680~4170mA		
	OPEN CIRCUIT VOLTAGE (max.)	60V		
	CURRENT ADJ. RANGE	1400~4170mA		
	CURRENT RIPPLE	5.0%(@rated current)		
	CURRENT TOLERANCE	±5%		
SET UP TIME <small>Note.5</small>	500ms/230VAC			
INPUT	VOLTAGE RANGE <small>Note.2</small>	120 ~ 305VAC 170VDC ~ 431VDC (Please refer to "STATIC CHARACTERISTIC" and "DRIVING METHODS OF LED MODULE"section)		
	FREQUENCY RANGE	47 ~ 63Hz		
	POWER FACTOR (Typ.)	PF ≥ 0.95 / 230VAC, PF ≥ 0.92 / 277VAC at full load (Please refer to "Power Factor Characteristic" section)		
	TOTAL HARMONIC DISTORTION	THD < 10% (@ load ≥ 60%/230VAC , @load ≥ 75%/277VAC) Please refer to "TOTAL HARMONIC DISTORTION (THD)" section		
	EFFICIENCY (Typ.)	93.0%		
	AC CURRENT (Typ.)	1A / 230VAC 0.8A / 277VAC		
	INRUSH CURRENT(Typ.)	COLD START 65A(twidth=500μs measured at 50% I _{peak}) at 230VAC; Per NEMA 410		
	MAX. NO. of PSUs on 16A CIRCUIT BREAKER	5 unit(circuit breaker of type B) / 8 units(circuit breaker of type C) at 230VAC		
PROTECTION	LEAKAGE CURRENT	<0.35mA / 294VAC		
	SHORT CIRCUIT	Hiccup mode, recovers automatically after fault condition is removed		
	OVER VOLTAGE	60~70V Shut down output voltage, re-power on to recovery		
ENVIRONMENT	OVER TEMPERATURE	Shut down output voltage, re-power on to recovery		
	WORKING TEMP.	T _{case} =-25 ~ +85°C (Please refer to "OUTPUT LOAD vs TEMPERATURE" section)		
	MAX. CASE TEMP.	T _{case} =+85°C		
	WORKING HUMIDITY	20 ~ 95% RH non-condensing		
	STORAGE TEMP.	-40 ~ +80°C		
	TEMP. COEFFICIENT	±0.03%/°C (0 ~ 60°C)		
SAFETY & EMC	VIBRATION	10 ~ 500Hz, 2G 12min./1cycle, period for 72min. each along X, Y, Z axes		
	SAFETY STANDARDS <small>Note.4</small>	ENEC BS EN/EN61347-1, BS EN/EN61347-2-13 independent, BS EN/EN62384, EN60335-1 EAC TP TC 004, GB19510.1,GB19510.14 approved		
	WITHSTAND VOLTAGE	I/P-O/P:3.86KVAC		
	ISOLATION RESISTANCE	I/P-O/P:100M Ohms / 500VDC / 25°C / 70% RH		
	EMC EMISSION <small>Note.4</small>	Parameter	Standard	Test Level/Note
		Conducted	BS EN/EN55015(CISPR15)/55014, GB/T17743	-----
		Radiated	BS EN/EN55015(CISPR15)/55014, GB/T17743	-----
		Harmonic Current	BS EN/EN61000-3-2 ,GB/T17625.1	Class C @load≥60%
	EMC IMMUNITY	Voltage Flicker	BS EN/EN61000-3-3	-----
		Parameter	Standard	Test Level/Note
		ESD	BS EN/EN61000-4-2	Level 3, 8KV air ; Level 2, 4KV contact
Radiated		BS EN/EN61000-4-3	Level 2	
EFT/Burst		BS EN/EN61000-4-4	Level 2	
Surge		BS EN/EN61000-4-5	1KV/Line-Line	
Conducted		BS EN/EN61000-4-6	Level 2	
Magnetic Field		BS EN/EN61000-4-8	Level 2	
Voltage Dips and Interruptions	BS EN/EN61000-4-11	>95% dip 0.5 periods, 30% dip 25 periods, >95% interruptions 250 periods		
OTHERS	MTBF	2883.5K hrs min. Telcordia SR-332 (Bellcore) ; 298.8K hrs min. MIL-HDBK-217F (25°C)		
	DIMENSION	330*35*22mm (L*W*H)		
	PACKING	0.31Kg; 48pcs / 15.9Kg / 0.79CUFT		
NOTE	<p>1. All parameters NOT specially mentioned are measured at 230VAC input, rated current and 25°C of ambient temperature.</p> <p>2. De-rating is needed under low input voltages. Please refer to "STATIC CHARACTERISTIC" sections for details.</p> <p>3. Please refer to "DRIVING METHODS OF LED MODULE".</p> <p>4. This series meets the typical life expectancy of 50000 hours of operation when T_{case}, particularly (T_c) point (or T_{MP}, per DLC), is about 75°C or less.</p> <p>5. Length of set up time is measured at first cold start. Turning ON/OFF the driver may lead to increase of the set up time.</p> <p>6. The driver is considered as a component that will be operated in combination with final equipment. Since EMC performance will be affected by the complete installation, the final equipment manufacturers must re-qualify EMC Directive on the complete installation again.</p> <p>7. Ripple & noise are measured at 20MHz of bandwidth by using a 12" twisted pair-wire terminated with a 0.1uf & 47uf parallel capacitor.</p> <p>8. Please refer to the warranty statement on MEAN WELL's website at http://www.meanwell.com</p> <p>9. The ambient temperature derating of 3.5°C/1000m with fanless models and of 5°C/1000m with fan models for operating altitude higher than 2000m(6500ft).</p> <p>10. For 56v model applications whose output voltage is less than 30V, the upper input voltage is 295VAC.</p> <p>11. RCM is on a voluntary basis. An Non IC classification Independent LED control gear is not suitable for residential installations but recommend to be used for commercial decoration / sign board / luminaire lighting purpose.</p> <p>12. To fulfill requirements of the latest ErP regulation for lighting fixtures, this LED driver can only be used behind a switch without permanently connected to the mains.</p> <p>※ Product Liability Disclaimer : For detailed information, please refer to https://www.meanwell.com/serviceDisclaimer.aspx</p>			

■ BLOCK DIAGRAM

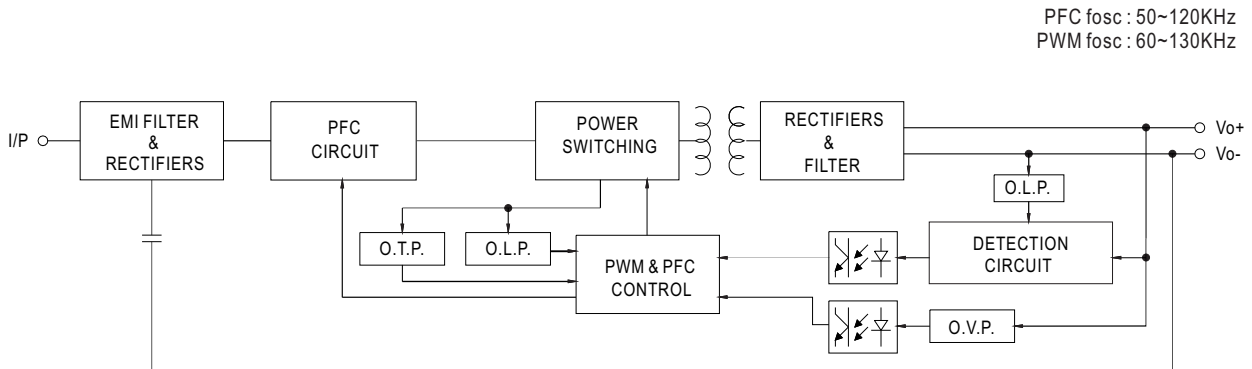

■ DRIVING METHODS OF LED MODULE

◎ SLD-150-12,24

- ✗ This series is able to work in either Constant Current mode (a direct drive way) or Constant Voltage mode (usually through additional DC/DC driver) to drive the LEDs.

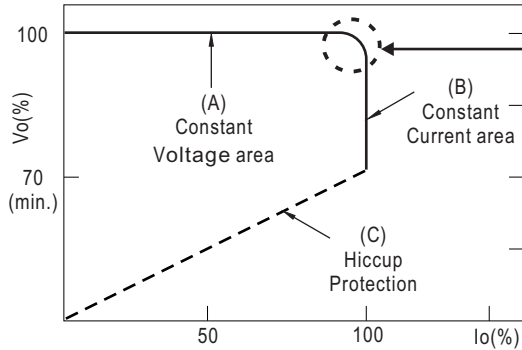

Typical output current normalized by rated current (%)

In the constant current region, the highest voltage at the output of the driver depends on the configuration of the end systems.
Should there be any compatibility issues, please contact MEAN WELL.

◎ SLD-150-56

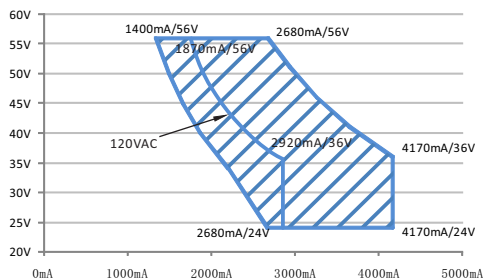

Recommend Performance Region

OUTPUT LOAD vs TEMPERATURE

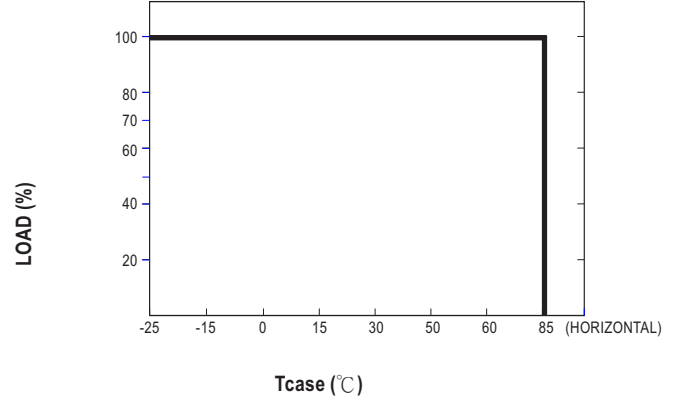
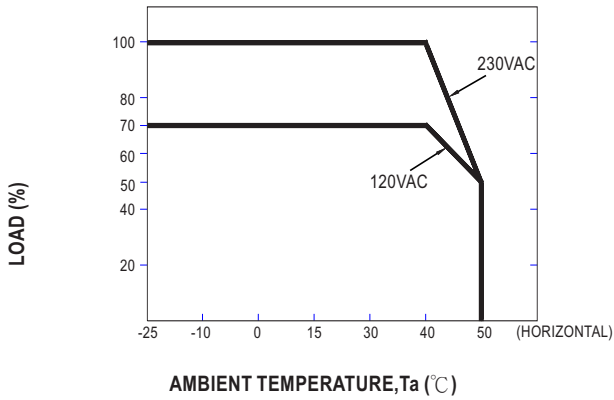

STATIC CHARACTERISTIC

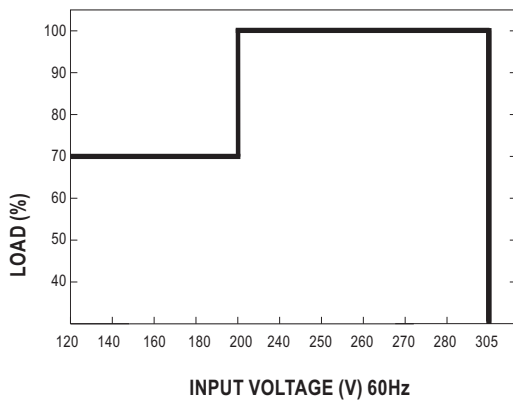

※ De-rating is needed under low input voltage.

POWER FACTOR (PF) CHARACTERISTIC

※ 24V Model, Tcase at 75°C

Constant Current Mode

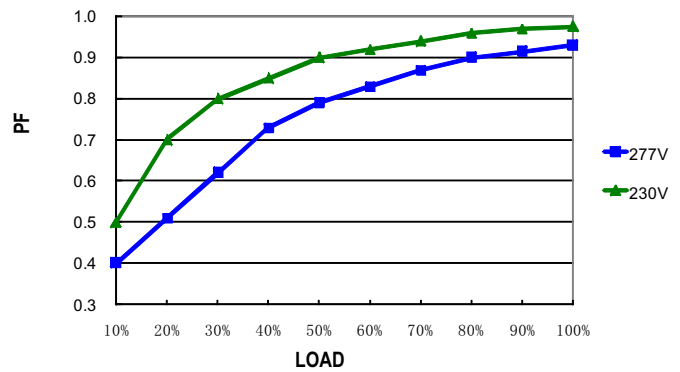

TOTAL HARMONIC DISTORTION (THD)

※ 24V Model, Tcase at 75°C

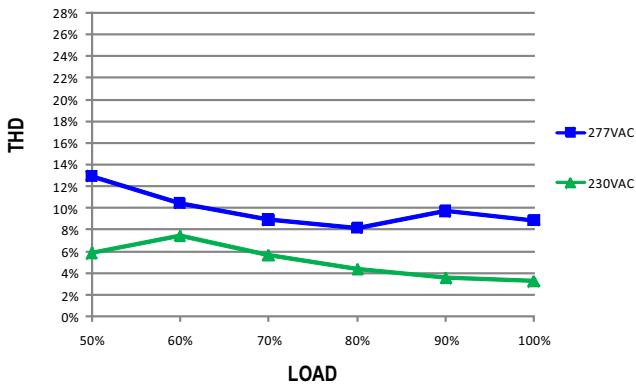

EFFICIENCY vs LOAD

SLD-150 series possess superior working efficiency that up to 92% can be reached in field applications.

※ 24V Model, Tcase at 75°C

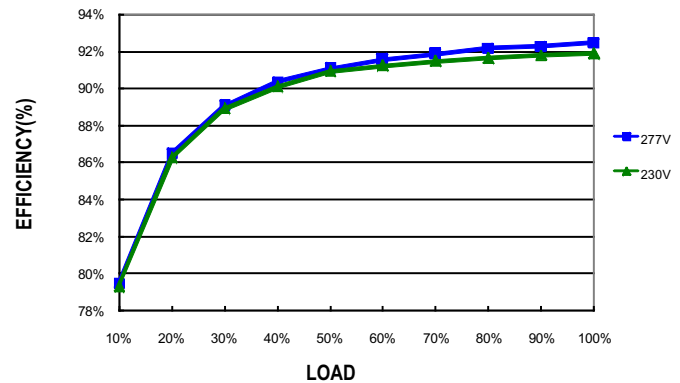

■ LIFE TIME

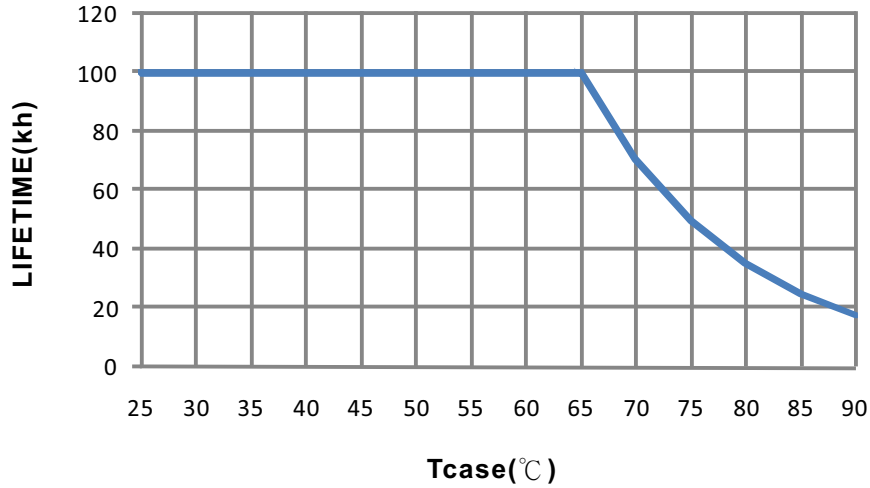

■ Mechanical Specification

Case No. SLD-150

Unit:mm

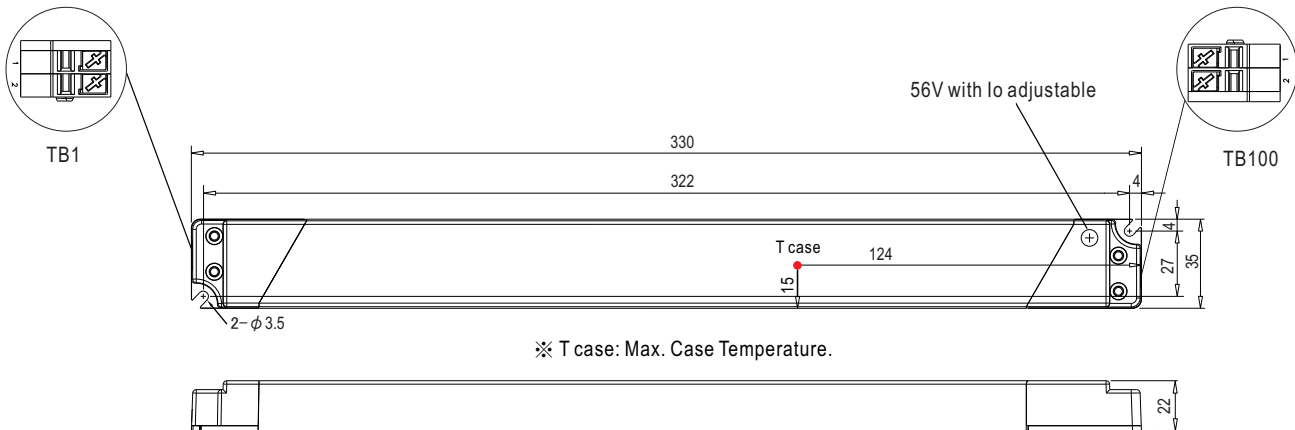

TB1 wiring:

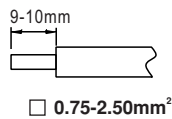

Terminal Pin No. Assignment (TB1) :
DEGSON DG202-5.0(GRAY)

Pin No.	Assignment
1	AC/L
2	AC/N

TB100 wiring:

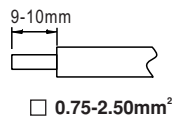

Terminal Pin No. Assignment (TB100) :
DEGSON DG202-5.0((RED/BLACK)

Pin No.	Assignment
1	+V
2	-V

■ INSTALLATION MANUAL

Please refer to : <http://www.meanwell.com/manual.html>