

# Ultracell®

'Quality in Every Language'

UCG275-12

12V 275Ah (C<sub>10</sub>)

12V 316Ah (C<sub>100</sub>)

Solar Series

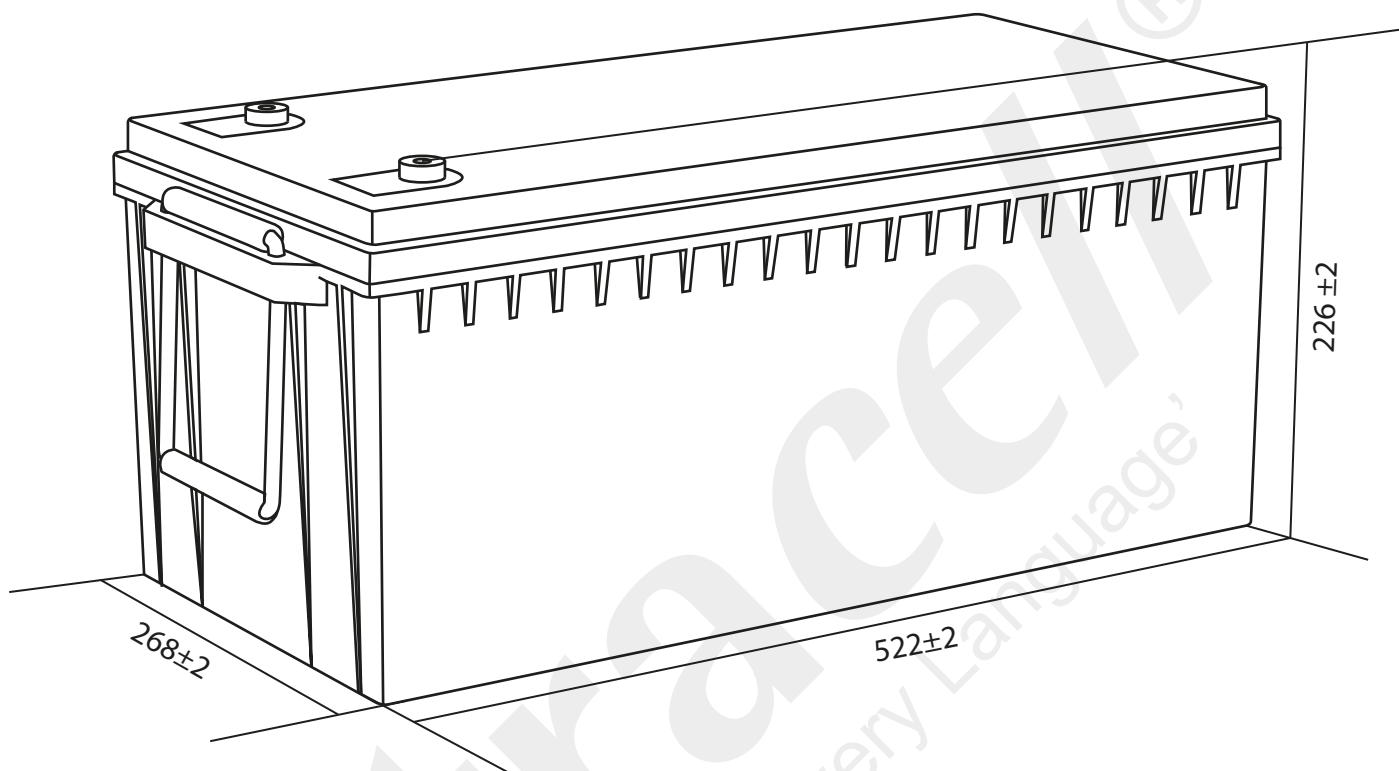

## Technical Dimensions (mm)

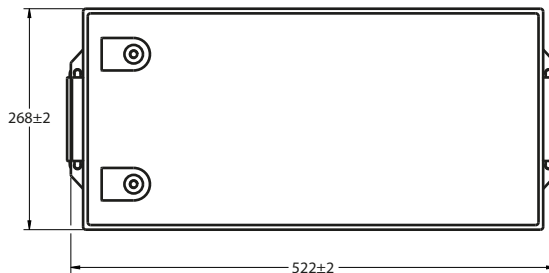
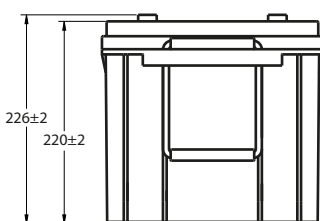
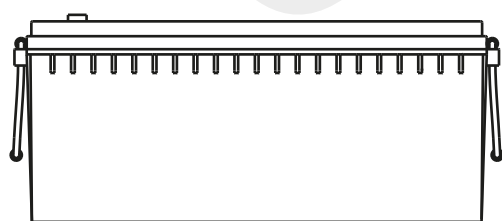



Image



Terminal Dimensions (mm)

Standard Terminal: F11

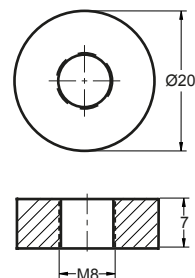

Technical Specification

<b>Output</b>	Nominal Voltage	12V
	Nominal Capacity (10HR)	275Ah
<b>Terminal Type</b>	Standard Terminal	F11
<b>Container Material</b>	Standard Option	ABS
	Flame Retardant Option (FR)	ABS (UL94:VO)
<b>Rated Capacity</b>	(100HR 1.80V/cell, 25°C)	316 Ah/3.16A
	(20HR 1.80V/cell, 25°C)	278.0 Ah/13.9A
	(10HR 1.80V/cell, 25°C)	275.0 Ah/27.5A
	(5HR 1.75V/cell, 25°C)	240.0 Ah/48.1A
	(1HR 1.60V/cell, 25°C)	171.0 Ah/171.0A
<b>Max Discharge Current</b>	2700A (5s)	
<b>Internal Resistance</b>	Approx 2.3mΩ	
<b>Discharge Characteristics</b>	Operating Temp Range	Discharge: -15 ~ 50°C Charge: -10 ~ 50°C Storage: -20 ~ 50°C
	Nominal Operating Temp Range	25 ± 3°C
	Cycle Use	Initial Charging Current less than 82.5A. Voltage 14.4V ~ 15.0V @ 25°C Temp. Coefficient -30mV/°C
	Standby Use	No limit on initial charging current. Voltage 13.5V ~ 13.8V @ 25°C Temp. Coefficient -20mV/°C
	Capacity affected by Temperature	40°C 103% 25°C 100% 0°C 86%
<b>Design Floating Life at 20°C</b>	15 Years	

Self Discharge

Ultracell® UCG batteries may be stored for up to 6 months at 25°C and then a refresh charge is required. For higher temperatures the time intervals will be shorter.

Constant Current Discharge / Constant Power Discharge At 25°C (Amperes & Watts/Cell)

A = Amperes W = Watts

F.V/TIME	10 min	15 min	20 min	30 min	45 min	60 min	2 hours	3 hours	4 hours	5 hours	6 hours	8 hours	10 hours	20 hours
A	W	W	W	W	W	W	W	W	W	W	W	W	W	W
1.85V/cell	316.9	269.5	225.4	178.1	172.3	111.9	71.2	55.3	48.8	46.6	33.6	30.1	25.2	12.5
	589.8	506.7	428.1	341.3	261.2	216.9	138.6	108.1	89.1	75.9	66.4	54.3	46.1	24.9
1.80V/cell	399.0	320.8	262.6	205.0	173.5	124.5	77.3	59.4	48.9	47.5	36.1	30.2	27.5	13.9
	734.5	595.7	491.8	387.9	294.2	240.0	149.8	115.5	94.4	81.3	70.9	57.7	49.6	25.6
1.75V/cell	447.4	357.7	288.3	218.5	174.4	131.7	81.1	61.5	50.0	48.1	37.1	30.4	27.8	13.9
	809.9	655.4	534.4	410.0	308.5	252.6	156.5	119.3	97.3	83.1	72.7	58.5	50.0	25.8
1.70V/cell	493.4	386.4	306.5	230.5	175.5	147.5	85.1	63.6	51.5	48.2	37.9	30.5	28.1	14.1
	871.5	697.0	563.0	429.4	322.1	262.6	163.6	123.1	100.0	85.0	74.1	59.3	50.2	26.3
1.65V/cell	---	406.9	322.5	241.4	175.6	152.4	87.4	66.0	53.0	48.4	38.7	30.6	28.4	14.4
	---	726.9	586.8	445.6	329.2	270.2	167.1	127.2	102.6	86.7	75.5	60.0	50.6	26.5
1.60V/cell	---	438.7	346.3	256.5	185.7	171.0	90.6	68.3	54.3	48.7	39.5	30.9	29.1	14.5
	---	770.7	623.2	469.6	345.8	281.7	172.4	131.0	104.6	88.1	76.9	60.7	51.4	26.7



**Discharge Characteristics**

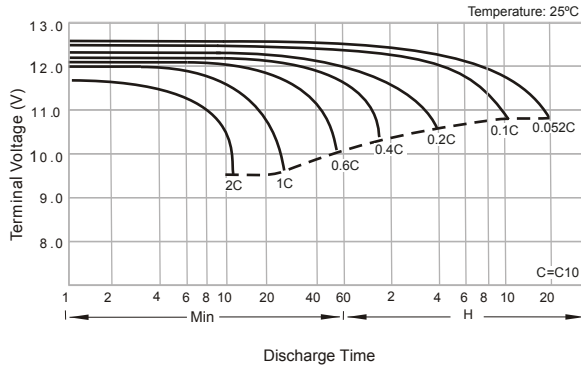

**Float Charging Characteristics**

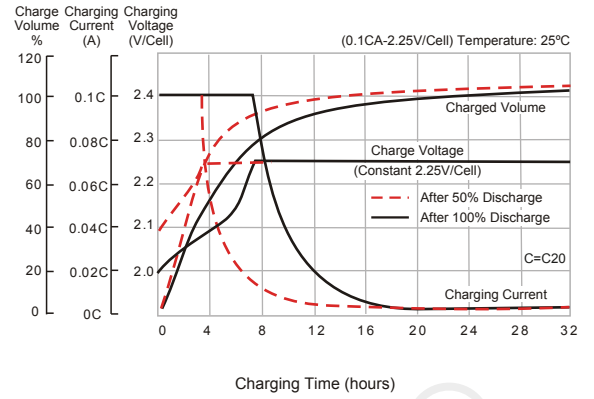

**Temperature Effects in Relation to Battery Capacity**

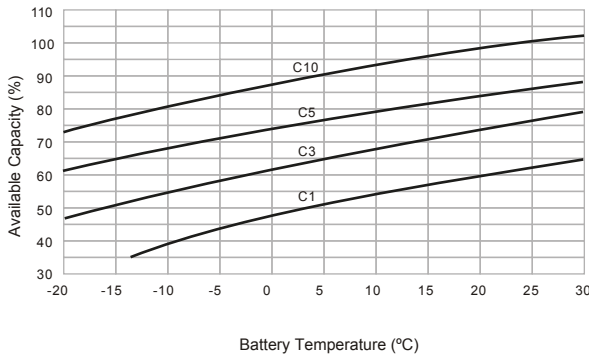

**Effect of Temperature on Long Term Float Life**

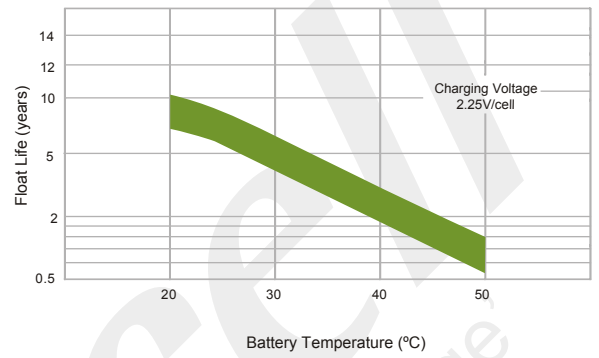

**Cycle Life in Relation to Depth of Discharge**

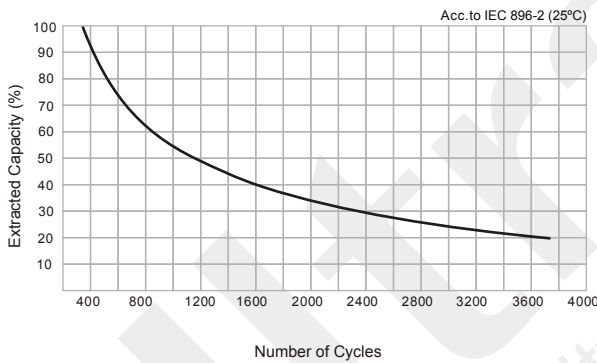

**General Relation of Capacity vs. Storage Time**

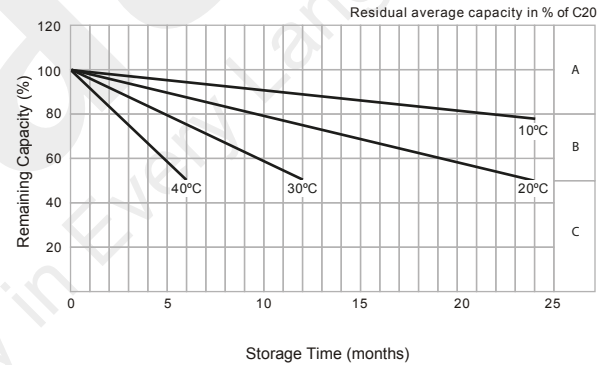

**General Relation of Capacity vs. Storage Time (Notes)**

- A) No supplementary charge required.  
(Carryout supplementary charge before use if 100% capacity is required.)
- B) Supplementary charge required before use. Optional charging way as below:
  1. Charged for above 3 days at limited current 0.25CA and constant voltage 2.25V/cell.
  2. Charged for above 20 hours at limited current 0.25CA and constant voltage 2.25V/cell.
  3. Charged for 8 ~ 10 hours at limited current 0.05 CA.
- C) Supplementary charge may often fail to recover the capacity.  
The battery should never be left standing till this is reached.