

# PeakTech®

Unser Wert ist messbar...



**PeakTech® 6181**

**Operation manual**

**Programmable linear laboratory power supply**

## Table of contents

|             | <b>Topic</b>  | <b>Page</b> |
|-------------|---|-------------|
| <b>1.</b>   | <b>Safety instructions for operating the device</b> | <b>1</b>    |
| <b>2.</b>   | <b>Introduction</b>                                 | <b>2</b>    |
| <b>3.</b>   | <b>Quick start</b>                                  | <b>3</b>    |
| <b>3.1.</b> | <b>Front/rear panel and user interface</b>          | <b>4</b>    |
| 3.1.1.      | Front   |             |
| 3.1.2.      | Back  |             |
| 3.1.3.      | User interface                                      |             |
| <b>3.2.</b> | <b>General inspection</b>                           | <b>7</b>    |
| <b>3.3.</b> | <b>Switch-on control</b>                            | <b>7</b>    |
| <b>3.4.</b> | <b>Output control</b>                               | <b>7</b>    |
| 3.4.1.      | Voltage output test                                 |             |
| 3.4.2.      | Current output test                                 | <b>8</b>    |
| <b>4.</b>   | <b>Controls on the front panel</b>                  |             |
| 4.1.        | Enable/disable the outputs                          |             |
| 4.2.        | Set output voltage and current                      |             |
| 4.3.        | Overvoltage and overcurrent protection              | <b>9</b>    |
| 4.3.1.      | Set overvoltage protection value                    |             |
| 4.3.2.      | Set overcurrent protection value                    | <b>10</b>   |
| <b>4.4.</b> | <b>Programmable output</b>                          | <b>11</b>   |
| 4.4.1.      | Data view   |             |
| 4.4.2.      | Output settings                                     |             |
| 4.4.3.      | Data Process  |             |
| 4.4.4.      | Enable/disable programmable output                  | <b>13</b>   |
| <b>4.5.</b> | <b>Save settings and Auto record</b>                |             |
| 4.5.1.      | Save settings                                       |             |
| 4.5.2.      | Auto Record   | <b>14</b>   |
| 4.5.3.      | View Record   |             |
| <b>4.6.</b> | <b>Output mode</b>                                  | <b>15</b>   |
| <b>4.7.</b> | <b>Utility (System) - Settings</b>                  | <b>18</b>   |
| 4.7.1.      | Select language                                     |             |
| 4.7.2.      | Brightness  |             |
| 4.7.3.      | Summer  |             |
| 4.7.4.      | Time  |             |
| <b>4.8.</b> | <b>System information</b>                           |             |
| 4.8.1.      | Show system information                             |             |
| 4.8.2.      | Default settings                                    |             |
| 4.8.3.      | Update  | <b>19</b>   |
| <b>4.9.</b> | <b>Port settings</b>                                |             |
| 4.9.1.      | Serial interface                                    |             |
| 4.9.2.      | Lan interface                                       | <b>20</b>   |
| 4.9.3.      | LCD test  |             |
| 4.9.4.      | Keys test   |             |
| <b>5.</b>   | <b>Troubleshooting</b>                              | <b>21</b>   |
| <b>6.</b>   | <b>Technical specifications</b>                     | <b>22</b>   |
| <b>7.</b>   | <b>Appendix</b>                                     | <b>23</b>   |

## **1. safety instructions for operating the device**

This product complies with the requirements of the following European Union Directives for CE conformity: 2014/30/EU (Electromagnetic Compatibility), 2014/35/EU (Low Voltage), 2011/65/EU (RoHS).

To ensure the operational safety of the device and to avoid serious injuries due to current or voltage flashovers or short circuits, the following safety instructions for operating the device must be observed.

Damages caused by non-observance of these instructions are excluded from claims of any kind.

- This device must not be used in high energy circuits.
- Before connecting the device to a power outlet, check that the voltage setting on the device matches the existing mains voltage
- Connect the device only to sockets with grounded protective conductor
- Do not place the device on a damp or wet surface.
- Check the device, test leads and other accessories for possible damage or bare or kinked cables and wires before commissioning. If in doubt, do not carry out any measurements
- Replace defective fuses only with a fuse corresponding to the original value. Never short-circuit the fuse or fuse holder.
- It is essential to keep the ventilation slots in the housing free (if covered, there is a risk of heat accumulation inside the device).
- Do not insert any metal objects through the ventilation slots.
- Do not place any liquids on the device (risk of short circuit if the device tips over).
- Do not operate the device near strong magnetic fields (motors, transformers, etc.)
- Never operate the device if it is not completely closed.
- Use only 4mm safety test cable sets to ensure proper functioning of the device.
- Only carry out measurement work in dry clothing and preferably in rubber shoes or on an insulating mat.
- It is essential to observe the warnings on the device.
- Device must not be operated unattended
- Do not expose the device to extreme temperatures, direct sunlight, extreme humidity or moisture.
- Avoid strong vibration.
- Keep hot soldering guns away from the immediate vicinity of the device.
- Before starting the measuring operation, the device should be stabilized to the ambient temperature (important when transporting from cold to warm rooms and vice versa)
- Clean the housing regularly with a damp cloth and a mild cleaning agent. Do not use any corrosive scouring agents.
- This device is suitable for indoor applications only.
- Avoid any proximity to explosive and flammable substances.
- Opening of the device and maintenance and repair work may only be carried out by qualified service technicians.
- Do not place the device with its front side on the workbench or work surface to avoid damage to the controls.
- Do not make any technical modifications to the device.
- -Measuring instruments do not belong in children's hands-

### **Cleaning of the device:**

Before cleaning the device, disconnect the power plug from the socket. Clean the device only with a damp, lint-free cloth. Use only commercially available detergents. When cleaning, make absolutely sure that no liquid gets into the interior of the device. This could lead to a short circuit and destruction of the device.

## 2. introduction

The innovative PeakTech 6181 power supply with color TFT display combines the advantages of a linear-controlled laboratory power supply with the remote control options that were previously mostly reserved for switching power supplies. Operation is via the graphical menu navigation and enables uncomplicated control and programming of the many functions. In addition, the device can be completely remote controlled via the enclosed PC software. To double the output voltage or output current values, the two independent channels can be connected in series or parallel. A plus/minus connection of the outputs is also possible.

### Features

- three separate outputs
- Residual ripple U:  $\leq 0.01\% + 3\text{mV}$
- four working modes: separate, parallel, serial, plus-minus
- up to 100 sequence steps programmable
- High resolution and accuracy
- 3.9" TFT (480x320 pixels)
- Interfaces: USB 2.0 (Device + Host), RS232 and LAN

### Safety symbols

The following symbols may appear in this manual:

 **Warning:** Indicates that certain conditions or activities may result in life-threatening injuries.

 **Caution:** Indicates that certain conditions or activities may cause damage to the device, or other objects can lead.

### Notes on the device

The following labels may be attached to the device, e.g. together with an explanation:







**Danger:** Injury or endangerment is possible immediately.

**Warning:** Injury or hazard is likely.

**Caution:** Potential risk of permanent damage to the device or its peripherals.

### Safety symbols

The following symbols may appear both on the device and in these instructions:

|  |                          |   |                      |
|--|--------------------------|---|----------------------|
|  | Life threatening voltage |  | See instructions     |
|  | PE connection            |  | Case grounding point |
|  | Ground connection        |  |                      |

### **NOTICE:**

Laboratory power supplies are not designed for charging batteries. Such use may cause serious damage to the device, which is excluded from claims of any kind.

### **3. quick start**

The following chapter includes:

- Overview of the front and back
- User interface overview
- Initial test of the power supply unit
- Checking the power supply functions
- Checking compliance with the initial values
- Description of the four working modes
- Description of the system menu

## 3.1 Front/rear panel and user interface

### 3.1.1. front side

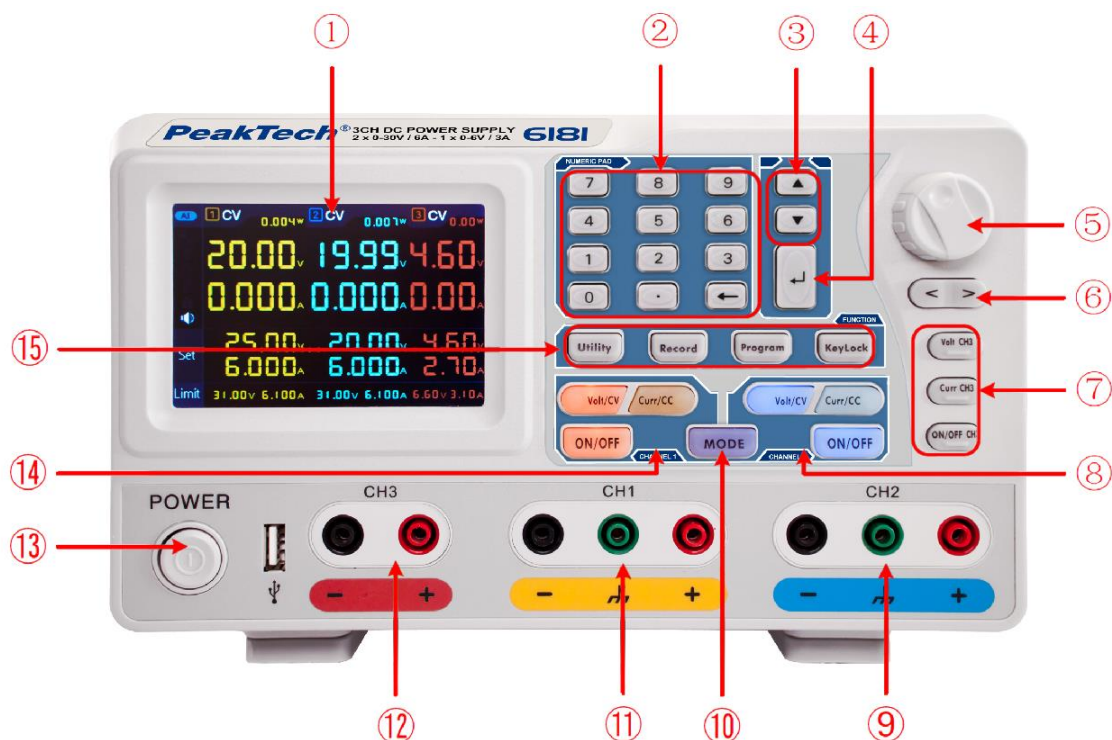

Picture: Front panel of the PeakTech 6180

|   |  |   |
|---|--|---|
| ① | <b>LCD</b>                                   | Display   |
| ② | <b>Number field</b>                          | Parameter input. Number keys, decimal point and reset key included.   |
| ③ | <b>Up" and "Down" keys</b>                   | Selection menu or parameter change  |
| ④ | <b>Enter key</b>                             | Selection of a menu item or confirmation of the set parameter   |
| ⑤ | <b>Rotary knob</b>                           | Selection of a menu item or confirmation of the set parameter. Pressing the button has the same effect as pressing the Enter key  |
| ⑥ | <b>Keys "to the left" and "to the right"</b> | Selection menu or moving the cursor   |
| ⑦ | <b>Channel 3 Operation</b>                   | <b>Volt/CH3</b> : Sets voltage for channel 3<br><b>Curr/CH3</b> : Sets current for channel 3<br><b>ON/OFF</b> : activate/deactivate output of channel 3   |
| ⑧ | <b>Channel 2 Operation</b>                   | <b>Blue Volt/CV</b> key: Sets the output voltage of channel 2<br><b>Blue Curr/CC</b> key: Sets the output current of channel 2<br><b>Blue ON/OFF</b> key: activate/deactivate output of channel 2   |
| ⑨ | <b>Channel 2 connection sockets</b>          | Connection sockets of channel 2 with polarity indication on blue field  |
| ⑩ | <b>Mode button</b>                           | Switches between working modes (CH1 & CH2 & CH3), as well as dual channel mode (CH1 & CH2)  |
| ⑪ | <b>Channel 1 connection sockets</b>          | Connection sockets of channel 1 with polarity indication on yellow field  |
| ⑫ | <b>Channel 3 connection sockets</b>          | Connection sockets of channel 3 with polarity indication on blue field  |
| ⑬ | <b>Power switch</b>                          | Power switch of the device for switching on/off   |
| ⑭ | <b>Channel 1 Operation</b>                   | <b>Orange Volt/CV</b> key: Sets the output voltage of channel 1<br><b>Orange Curr/CC</b> key: Sets the output current of channel 1<br><b>Orange ON/OFF</b> key: activate/deactivate output of channel 1   |
| ⑮ | <b>Function keys</b>                         | <b>Utility</b> key: Menu for output mode, settings, info and interfaces<br><b>Record</b> button: Save settings, auto record and playback<br><b>Program</b> key: Programmable output programs<br><b>KeyLock</b> key: Press for 5 sec. to activate key lock. Press again for 5 sec. to deactivate key lock. |

## Explanation of the keypad display

|                |   |
|----------------|---|
| ON/OFF button  | Key lights up when the channel has been activated             |
| Volt/CV button | Key lights up when the channel is in constant voltage mode    |
| Curr/CC key    | Button lights up when the channel is in constant current mode |

### 3.1.2. back side

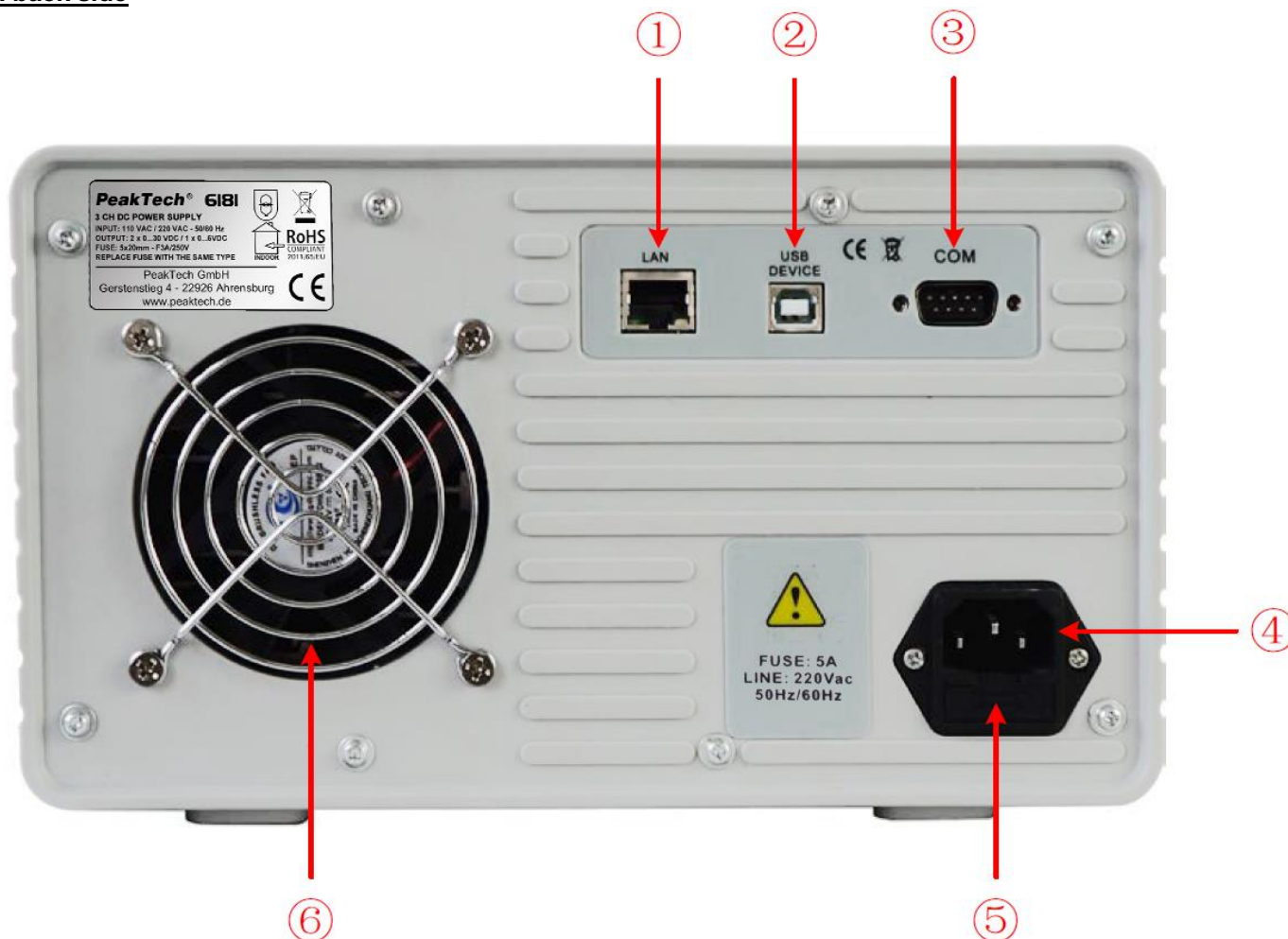

Image: back side

|   |                           |  |
|---|---------------------------|--|
| ① | <b>LAN (network) port</b> | For connection to a local network                                    |
| ② | <b>USB Device Port</b>    | USB slave port for connecting to a PC                                |
| ③ | <b>COM Port</b>           | Serial interface   |
| ④ | <b>Power input socket</b> | Power input socket   |
| ⑤ | <b>Fuse</b>               | Fuse (tripping characteristic depends on the selected mains voltage) |
| ⑥ | <b>Fan</b>                | Air inlet  |

### 3.1.3 User interface

When the output mode is in independent output mode or channel tracking mode, there are two display modes: three-channel mode (CH1 & CH2 & CH3), two-channel mode (CH1 & CH2). Press the Mode button to switch between modes.

#### Three channel mode

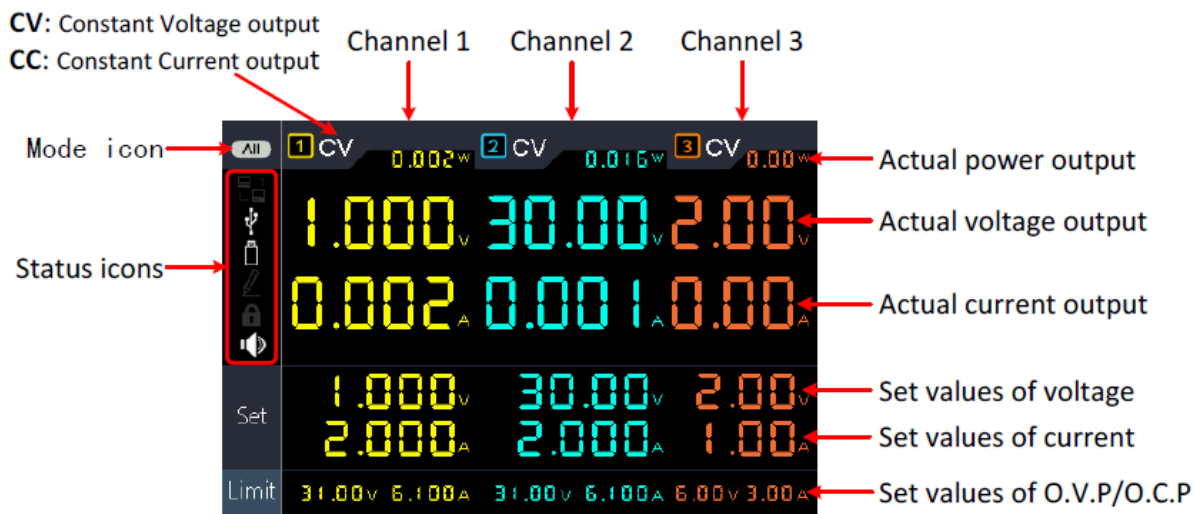

Image: User interface in three-channel mode

#### Two-channel mode

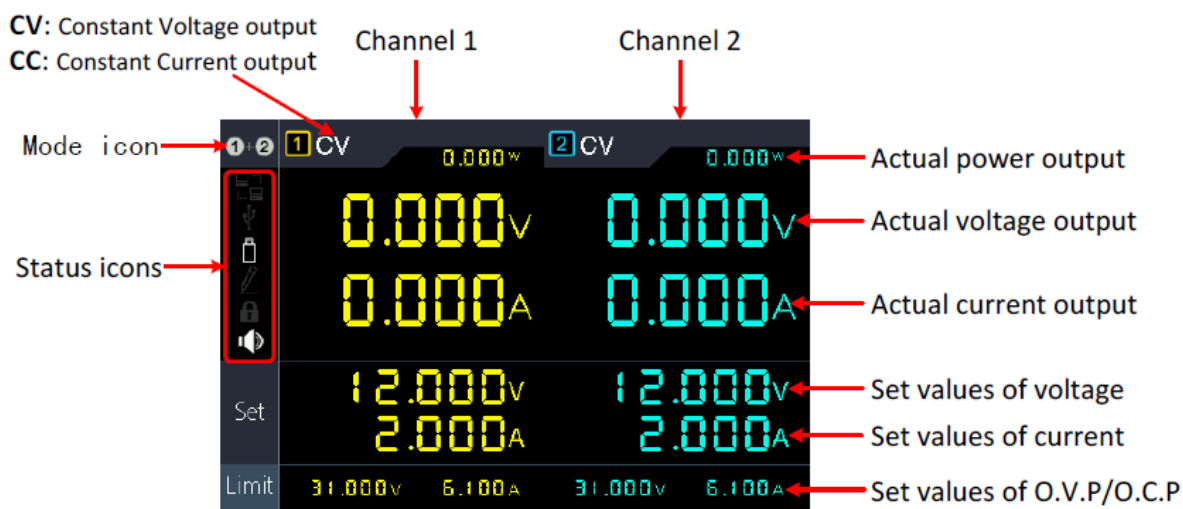







Image: User interface in two-channel mode

#### Mode icons

| Symbol                   | Description  |
|--------------------------|--|
| All                      | Three-channel mode for CH1, CH2 and CH3 is displayed |
| 1+2                      | Two-channel mode (CH1 & CH2) is displayed            |
| 1 2<br>- +<br>- +<br>- + | Parallel output mode enabled                         |
| 1 2<br>- +<br>- +<br>- + | Serial output mode enabled                           |



## Status icons

| Symbol  | Description  |
|---|--|
|  | Connected to LAN (network)                             |
|  | Connected as slave via USB                             |
|  | A USB memory is connected to the front USB host socket |
|  | Recording the current output values                    |
|  | Key lock activated                                     |
|  | Loudspeaker is activated                               |

## 3.2 General inspection

When you receive your new power supply, it is recommended to check the following steps:

### 1. check for transport damage

If the packing carton or foam protection is found to have damage, do not discard it until the complete unit and its accessories have been electrically and mechanically tested.

### 2. check the accessories

The supplied accessories are described in "Appendix A:" of this manual. Please Make sure all listed accessories are present and undamaged, if problems are found please contact your dealer or PeakTech directly.

### 3. check the device

If there is physical damage, operational error or a performance problem, please contact your dealer or directly to PeakTech. Please keep the original packaging. Ideally Should the device always be sent in the original packaging to avoid transprot damage.

## 3.3 Switch-on control

- (1) Connect the device to the power supply using the supplied power cable.

---

### Attention:

 To avoid electric shock, the device should only be connected to a grounded outlet. be connected

---

- (2) Press the power button on the front panel. The keys light up and the screen displays the Loading screen until the device switches to the user interface. This may take a few seconds.

## 3.4 Output control

Checking the output power ensures that the device can reach its rated power and rated output. For the following steps, we recommend that you first read the chapter on switching the channel output on / off and setting the output values.

### 3.4.1 Voltage output test

The following steps check basic voltage functions without load:

- (1) If the instrument is not loaded, select a channel and make sure that the current setting for that channel is not set to zero.

(2) Turn on the channel output and make sure the channel is in constant voltage (CV) mode.

(3) Set various voltage values on this channel; Check if the actual voltage value is displayed and also the actual current value is displayed as near zero.

(4) Check that the output voltage can be set from zero to the maximum rated voltage.

### **3.4.2 Current output test**

The following steps check basic power functions with a short circuit across the power supply  
Issue:

(1) Connect an insulated test lead to the (+) and (-) output terminals to create a short circuit. Use a wire diameter sufficient to handle the maximum current.

(2) Set the output voltage to the maximum value for this channel.

(3) Turn on the channel output. Make sure that the channel you are using is in Constant Current (CC) output mode.

(4) Set some different current values on this channel and check if the current value is displayed close to the set current value and check if the actual voltage value is displayed as close to zero due to the short circuit.

(5) Check that the output current can be set from zero to the maximum rated power.

(6) Turn off the channel output and remove the short circuit from the output terminals.

## **4. operating elements on the front panel**

### **4.1 Activating/deactivating the outputs**

- Press the orange **ON/OFF button** to enable/disable output of CH1.
- Press the blue **ON/OFF button** to enable/disable the output of the CH2.
- The **ON/OFF CH3 button** to enable/disable the output of the CH3.

### **4.2 Setting the output voltage and current**

You can enter the voltages and currents using the number field.

#### **Set output voltage for CH1**

- Press the orange **Volt/CV** key and the first digit of the CH1 voltage display flashes. Two input options are available:

**Change:** Turn the knob to change the value of the highlighted digit. The **</>** keys move the cursor by one digit.

**Input:** Use the number keys to enter the desired value. The old value will be overwritten.

- Press to **↵** confirm the entry.

#### **Set output voltage for CH2**

- Press the blue key **Volt/CV** and the first digit of the CH2 voltage display flashes. Carry out the settings as also described for channel CH1.

### Set output voltage for CH3

- Press the **Volt CH3** key and the first digit of the CH3 voltage display flashes. Carry out the settings as also described for channel CH1.

### Set output current for CH1

- Press the **orange Curr/CC** key and the first digit of the CH1 current display flashes. Two input options are available:

**Change:** Turn the knob to change the value of the highlighted digit. The **</>** keys move the cursor by one digit.

**Input:** Use the number keys to enter the desired value. The old value will be overwritten.

- Press to **↵** confirm the entry.

### Set output voltage at CH2

- Press the **blue Curr/CC** key and the first digit of the CH2 current display flashes. Carry out the settings as also described for channel CH1.

### Set output voltage at CH3

- Press the **Curr CH3** key and the first digit of the CH3 current display flashes. Carry out the settings as also described for channel CH1.

---

**Notice:**

If the value you have set is outside the specifications, an "ERROR" appears message and you have to select another value.

---

## 4.3 Overvoltage and overcurrent protection

If the overvoltage (O.V.P) or overcurrent (O.C.P) protection is activated, the power supply automatically switches off the output as soon as the set limit value has been exceeded. A corresponding warning is shown in the display.

---

**Note:**

If the output is deactivated as a result of an error, it must be deactivated after the error has been rectified. be activated manually.

---



This function can limit the power so as not to exceed the specifications of the connected load.



### 4.3.1 Setting the overvoltage protection

- **O. V. P. set for channel 1**



Press the **orange Volt/CV** key and the first digit of the CH1 voltage display flashes. Now press the **▼** key and the first digit of the CH1 OVP setting flashes.

Two input options are available:

- **Change:** Turn the knob to change the value of the highlighted digit. The   keys move the cursor by one digit.
- **Input:** Use the number keys to enter the desired value. The old value will be overwritten.
- Press to  confirm the entry.
- **Set OVP for channel 2**



Press the blue  key and the first digit of the CH2 voltage display flashes. Now press the  key and the first digit of the CH1 OVP setting flashes. Carry out the settings as for CH1.

- **Set OVP for channel 3**



Press the  key and the first digit of the CH3 voltage display flashes. Now press the  key and the first digit of the CH1 OVP setting flashes. Carry out the settings as for CH1.



#### 4.3.2 Setting the overcurrent protection

- **Set O.C.P. for channel 1**



Press the orange  key and the first digit of the CH1 current display flashes. Now press the  key and the first digit of the CH1 OCP setting flashes.

Two input options are available:

- **Change:** Turn the knob to change the value of the highlighted digit. The   keys move the cursor by one digit.
- **Input:** Use the number keys to enter the desired value. The old value will be overwritten.
- Press to  confirm the entry.
- **Set OVP for channel 2**

Press the blue  key and the first digit of the CH2 current display flashes. Now press the  key and the first digit of the CH1 OCP setting flashes. Perform the settings as for CH1.

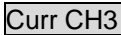
- **Set OVP for channel 3**

Press the  key and the first digit of the CH3 current display flashes. Now press the  key and the first digit of the CH1 OCP setting flashes. Perform the settings as for CH1.

## 4.4 Programmable output

The programmable output function can preset up to 100 groups of timing parameters. When you turn on the programmable output, the instrument outputs the preset voltage and current in the preset time duration.

### 4.4.1 Data view

Press the **Program** key. The **Data View** menu is selected

(1) The **Memory** submenu is active. Press **</>** to switch between **Internal** and **External**.

(2) Use the **▼** key to switch to the **Import** submenu. Press the **↵** key to import data.

(3) Use the **▼** key to switch to the **Export** submenu. Press the **↵** key to export data.

**Note:** If external is selected as the storage location, a folder (**ODP\Program**) will be created on the connected USB memory where the program will be saved as a CSV file for editing.

(4) Use the **▼** key and select the **Clear Data** submenu. Press the key to **↵** clear the data.

### 4.4.2 Output settings

Press the **Program** key and turn the knob to switch to the **Output Set** menu.

(1) The **Cycle Mode** submenu is active. Press **</>** to switch between **Order** (1x) and Loop.

(2) Use the **▼** key to switch to the **Start Point** submenu. Use the numeric keys to set the value of the start point of the table to run through. Press the **↵** key to confirm the entry.

(3) Use the **▼** key to switch to the **Stop Point** submenu. Use the numeric keys to set the value of the end point of the table to pass. Press the **↵** key to confirm the input.

(4) Use the **▼** key to switch to the **Start** submenu. Use the **</>** keys to switch between CH1, CH2 or ALL. Press the **↵** key to confirm the entry.





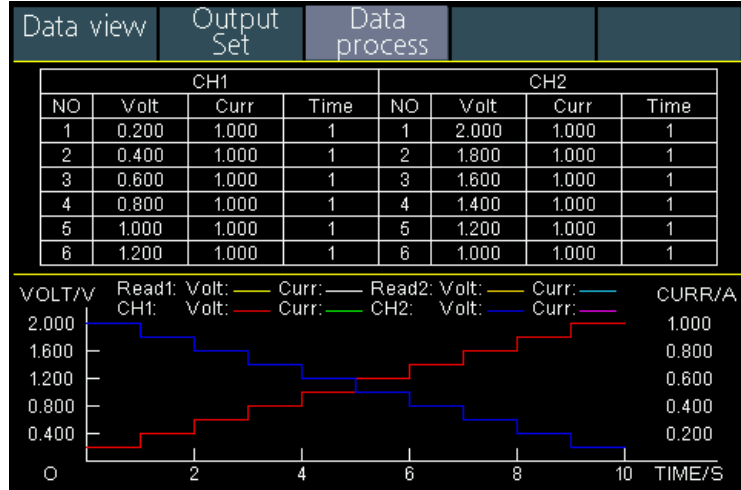

### 4.4.3 Data Process

Press the **Program** key and turn the knob to switch to the **Data Process** menu. You can set the parameters of CH1 and CH2 including voltage, current and output time. This function allows 100 parameter groups for each channel.









#### Edit:

- (1) The **Edit** submenu is active and shows a short overview of the function keys. Press the  key to switch to the data processing menu:



- (2) In the Data Process submenu, press the  /  keys to move the cursor of the selected digit one column to the left or right and the  /  keys to move the cursor one row up and down. Use the number keys to enter the desired value and press the  key to confirm.
- (3) Use the  Backspace key to switch back a menu.

**Graph process** is used to configure the graphical display in the data **process** interface:

- (1) Press the  key to enter the **Graph Process** submenu. Now press the  key to activate the editing menu.
- (2) In this menu, the setting and display options are shown as yellow boxes. Select the desired check box with the  /  keys or press the  /  keys to change the selection line. To activate/deactivate the check boxes for the individual menu items, press the  key. If the check box is activated, the corresponding line is displayed in the progress curve and the field is activated in the data processing menu.
- (3) Use the  Backspace key to switch back a menu.

#### 4.4.4 Switching the programmable output on and off

In the **Data Processing** menu:

- **Independent Mode (Normal)**  
Press the orange **ON/OFF button** to turn the programmable output of CH1 on and off.  
Press the blue **ON/OFF button** to turn the programmable output of CH2 on and off.
- **Parallel/Series Mode**  
Press the orange **ON/OFF key** to switch the programmable output on and off.

In the **Output Set** menu:

Press the **▼** key to enter the **Start** item. Now press the **</>** keys to select the channel (CH1, CH2 or All) and then press the **↵** key to activate the data processing menu and output the selected channel.

---

**Notice:**

When using the programmable output, pressing the ON/OFF key activates the timer. of the output is reset. If you switch the output on again, the time program starts automatically new from the beginning.

---

#### 4.5 Save settings and Auto Record

##### 4.5.1 Saving settings

You can save, recall and delete current setting parameters. The memory can be set as internal or external (USB flash device). Up to 100 groups of settings can be stored.







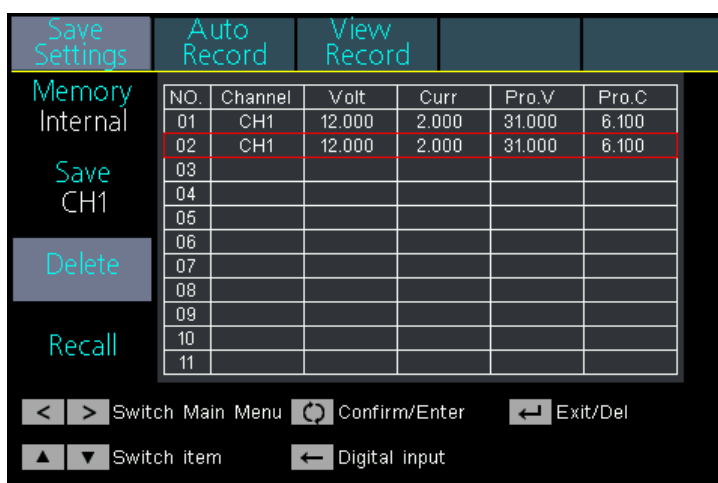

Press the **Record** key. The **Save Settings** menu is displayed.

- (1) The **Memory** submenu is active. Press **</>** to switch between **Internal** and **External**.
- (2) Use the **▼** key to switch to the **Save** submenu. Press **</>** to select the channel (CH1, CH2 or CH3) and then press the **↵** button to save the channel settings.

**Note:** If external is selected as the storage location, a folder (**P6181\Record\_Option**) is created on the connected USB memory in which the channel setting is saved as a CSV file.













- (3) Use the **▼** key and select the **Delete** submenu. Press the **↵** key and a red box will be displayed around the saved setting. Press the **▲/▼** keys to change the line or **</>** to change the page. Select the desired value and then press the **↵** key to delete the record. Use the Backspace key **←** to switch back a menu.



- (4) Use the  key and select the **Recall** submenu. Press the  key and a red box will be displayed around the saved setting. Press the  /  keys to change the line or  /  to change the page. Select the desired value, then press the  key to access the record. Use the Backspace key  to switch back one menu.

#### **4.5.2 Auto Record**

















Press the  button and select **Auto Record** via the rotary knob.

- (1) The **Memory** submenu is active. Press  /  to switch between **Internal** and **External**.
- (2) Use the  key to switch to the **Interval** submenu. Use the number keys to set the desired measurement interval and then press the  key to confirm the value.
- (3) Use the  key to switch to the **Points** submenu. Use the number keys to set the desired number of measurement points and then press the  key to confirm the value.
- (4) Use the  key to switch to the **Record Status** submenu. Press  /  to select the channel (CH1, CH2 or CH3) and then press the  key to start recording. Press the key  again to stop recording. During recording, the  symbol is shown in the display.

**Note:** If external is selected as the storage location, a folder (**P6181\Record\_Auto**) is created on the connected USB memory, in which the measured values are saved as a CSV file.

#### **4.5.2 View Record**

Press the  button and select **View Record** via the rotary knob.

- (1) Use the  key to select into the **Memory** submenu. Press  /  to switch between **Internal** and **External**.
- (2) If **Internal** is selected in the **Memory** submenu, press the  button to switch to the **Read** submenu and then press  /  to switch between **CH1, CH2 or CH3**. Then press the  button to confirm the channel. After successfully reading the data, the measured values will be tabulated and the current value will be highlighted in a red box. Use the  /  keys to switch between pages. Use the  Backspace key to switch back one menu. If **External** is selected in the **Memory** submenu, press the  key to switch to the **Export** submenu. Use the  /  keys to switch between **CH1, CH2 or CH3** and then the  key to export the selected value to a connected USB memory. A folder (**P6181\Record\_Auto**) is created on the connected USB memory where the measured values are saved as a CSV file.
- (3) Use the  key to switch to the **display** submenu. Press the  /  keys to select the display as **Graph** or **Table**.



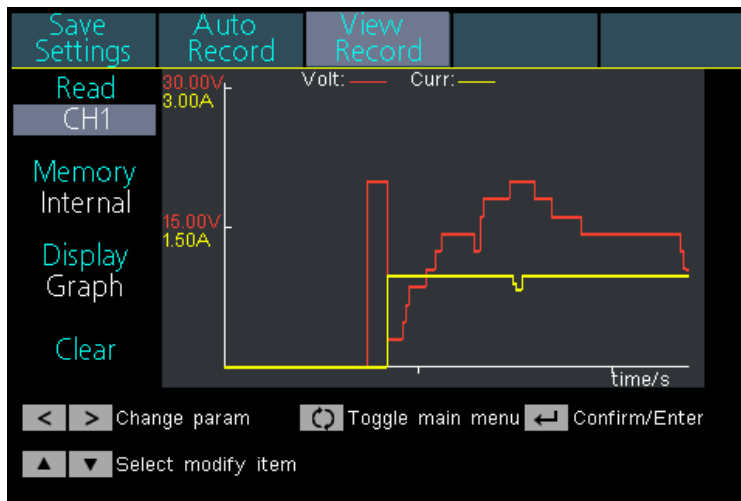



**Graph display**

| NO. | CH1    |       |        |
|-----|--------|-------|--------|
|     | Volt   | Curr  | Power  |
| 61  | 8.708  | 1.998 | 17.395 |
| 62  | 8.708  | 1.998 | 17.395 |
| 63  | 10.605 | 1.998 | 21.184 |
| 64  | 10.605 | 1.998 | 21.185 |
| 65  | 10.605 | 1.998 | 21.185 |
| 66  | 12.510 | 1.998 | 24.990 |
| 67  | 12.512 | 1.998 | 24.993 |
| 68  | 14.406 | 1.998 | 28.776 |
| 69  | 14.406 | 1.998 | 28.776 |
| 70  | 14.405 | 1.998 | 28.774 |

**Table display**

(4) Use the  key to switch to the **Clear** submenu. Press the key to clear the  measured values.

#### **4.6 Output mode**

The output mode can simplify the parameter input of CH1 and CH2. The output mode setting applies to CH1 and CH2 only, without affecting CH3. There are four output modes:

- **Independent Output (Independent Mode)**

The values for each channel can be set independently.

- **Parallel Track (Parallel Mode)**

When CH1 and CH2 are connected in parallel, you can select this mode to simplify parameter input. You only need to set the parameters of the combined channel. The nominal voltage is the same as for the single channel; the current value is the sum of the current values of CH1 and CH2.

Press the orange  to turn the combined channel on / off.

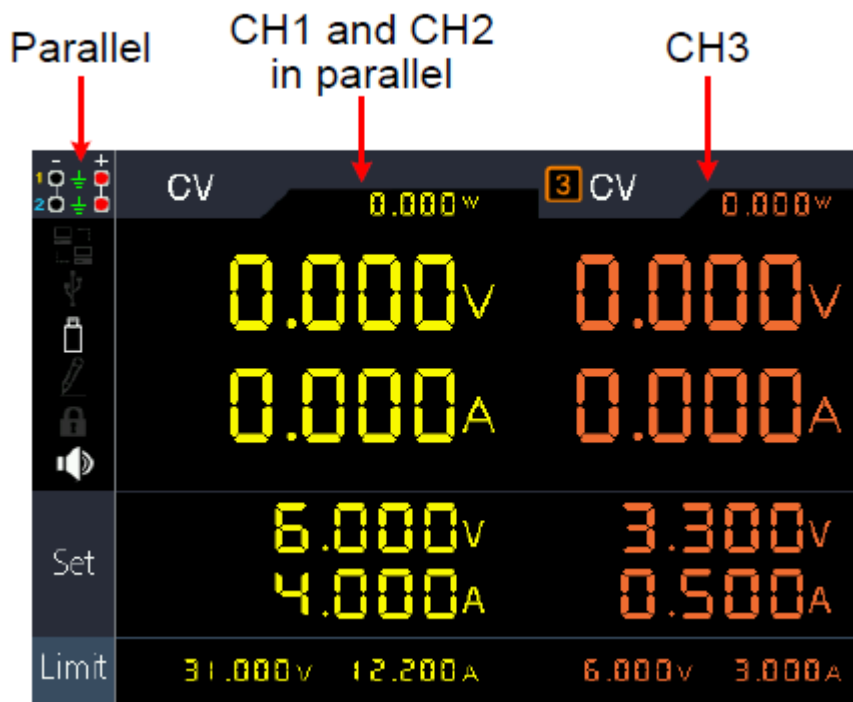

The connection method of parallel connection of CH1 and CH2 is as in the Figure described below:

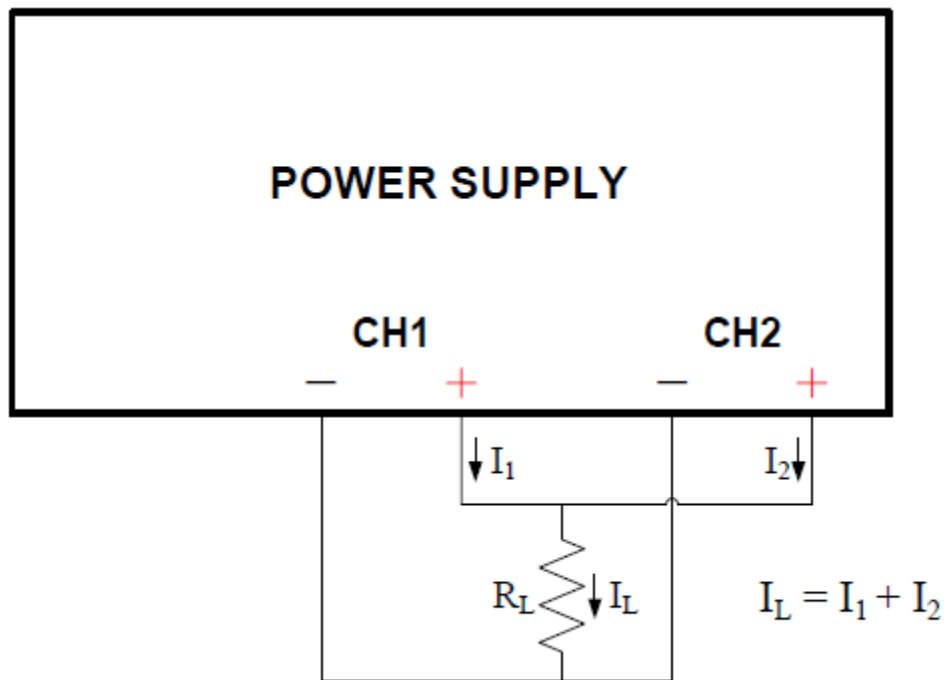

- **Series Track (Serial Mode)**

If CH1 and CH2 are serially connected, you can select this mode to simplify parameter input. You only need to set the parameters of the combined channel. The rated current is the same as for the single channel; the current voltage value is the sum of the output voltages of CH1 and CH2.

Press the orange **ON/OFF to** turn the combined channel on / off.

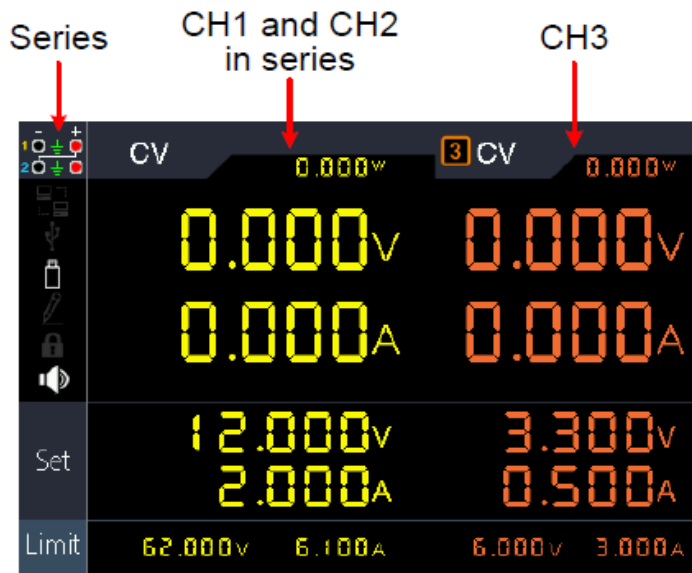

The connection method of the serial circuit of CH1 and CH2 is as shown in the Figure described below:

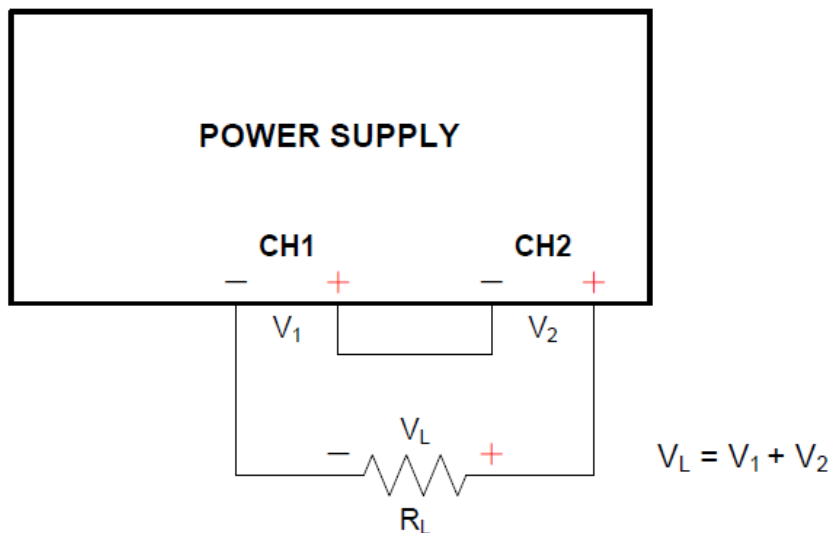

- **Channel Track (Dependent Mode)**

In independent output mode, set the output parameters of CH1 and CH2 and switch to Channel Track mode. When the parameters of one channel are changed, the other channel changes proportionally.

For example, in independent output mode, set CH1 voltage to 2V, current to 1A; set CH2 voltage to 4V, current to 2A. When CH1 voltage is set to 6V, CH2 voltage will be set to 12V proportionally after entering "Channel Track" channel tracking mode. If CH1 current is set to 2A, CH2 current will be set proportionally to 4A.

Note: If the setting value is outside the nominal range, it is set to the maximum.

**To set the output mode:**

- (1) Press the **Utility** key. The "Output Mode" menu is activated.
- (2) Use the **▲**/**▼** keys to select the desired mode and then use the key to **↵** select the mode.

## 4.7 Utility (System) settings

### 4.7.1 Language (Select language)

Press the **Utility** key. Use the rotary knob to switch to the **Utility** menu. The **Language** submenu is activated. Use the **</>** keys to switch through the menu languages.

### 4.7.2 Brightness (Setting the brightness of the display)

Press the **Utility** key. Use the rotary knob to switch to the **Utility** menu. Now press the **▼ key to switch to** the **Brightness** submenu. Use the **</>** keys to cycle through the display brightnesses. 0%, 25%, 50%, 75% and 100% can be selected.

### 4.7.3 Beeper (set buzzer)

Press the **Utility** key. Use the rotary knob to switch to the **Utility** menu. Now press the **▼ key to switch to** the **Beeper** submenu. Use the **</>** keys to switch the integrated buzzer on or off. If the buzzer is active, the corresponding symbol is  displayed in the info field. A short info tone is emitted in the event of system messages, e.g. warning messages due to OVP/OCP.

### 4.7.4 Clock (Set system time)

Press the **Utility** key. Use the rotary knob to switch to the **Utility** menu. Now press the **▼ key to** switch to the **Clock** submenu. Use the numeric keypad to fill in the corresponding numeric values and confirm with the key . Use the **</>** keys to advance to the next value.

## 4.8 System Info

### 4.8.1 Display system information

Press the **Utility** key, then the rotary knob to switch to the **Info** submenu. The serial number of the device, the software and hardware versions are displayed.

### 4.8.2 Default settings

Press the **Utility** key, then the knob to switch to the **Default** submenu. Press and  the default settings will be accessed. See the following table of PeakTech 6181 default settings.

|               | <b>Output</b> | <b>Volt</b> | <b>Power</b> |
|---------------|---------------|-------------|--------------|
| Output-values | CH1           | 12.00V      | 2.000A       |
|               | CH2           |             |              |
|               | CH3           |             |              |
|               | Parallel      | 12.000V     | 6.000A       |
|               | Serial        | 36.000V     | 2.000A       |

|               | <b>Output</b> | <b>Volt</b>         | <b>Power</b>          |
|---------------|---------------|---------------------|-----------------------|
| Limit-Setting | CH1           | Max. Output +1V     | Max. Output +0.1A     |
|               | CH2           |                     |                       |
|               | CH3           |                     |                       |
|               | Parallel      | Max. Output +1V     | 2 x Max. Output +0.1A |
|               | Serial        | 2 x Max. Output +1V | Max. Output +0.1A     |

|         |              |             |                  |        |
|---------|--------------|-------------|------------------|--------|
| Utility | Output mode  |             | Independent mode |        |
|         | Brightness   |             | 50 %             |        |
|         | Summer       |             | To               |        |
|         | Port         | Serial      | Baud             | 115200 |
|         |              |             | Data Bits        | 8      |
|         |              |             | Odd-Even         | None   |
|         |              |             | Stop Bits        | 1      |
|         | LAN Settings | IP address  | 192.168.001.099  |        |
|         |              | Subnet Mask | 255.255.255.000  |        |
|         |              | Gateway     | 192.168.001.001  |        |
| Port    |              | 3000        |                  |        |

|        |               |                  |          |
|--------|---------------|------------------|----------|
| Record | Save Settings | Location         | Internal |
|        |               | Stores           | CH1      |
|        | Car Record    | Location         | Internal |
|        |               | Interval         | 1        |
|        |               | Points           | 1000     |
|        |               | Recording Status | CH1      |
|        | View Record   | Read             | CH1      |
|        |               | Location         | Internal |
|        |               | Display          | Graphic  |

|         |            |                |          |
|---------|------------|----------------|----------|
| Program | Data View  | Location       | Internal |
|         | Output Set | Cycle mode     | One time |
|         |            | Starting point | 1        |
|         |            | Endpoint       | 100      |
|         |            | Data Process   | Graphics |

### 4.8.3 Update

Press the **Utility key** and turn the rotary knob until you are in the **Info** menu. Use the **▼** key to switch to the **Update** submenu. Now press the **↶** to load a firmware update from the connected USB stick, if available.

### 4.9 Port settings

#### 4.9.1 Serial interface





Press the **Utility** key and turn the knob until you are in the **Port Set** menu. The **Serial** menu is active.

- (1) Press the **↶** key to set the value of baud rate. Press the **◀/▶** keys to set the desired baud rate between 1200, 2400, 4800, 9600, 19200, 38400, 57600 or 115200. Default is 115200, make sure the baud rate matches the computer.
- (2) Use the **▼** key to activate the **Data Bits** submenu. Press the **◀/▶** keys to switch between 6, 7 or 8.
- (3) Use the **▼** key to activate the **Odd-Even** submenu. Press the **◀/▶** keys to switch between None, Odd or Even.
- (4) Use the **▼** key to activate the **Stop Bits** submenu. Press the **◀/▶** keys to switch between 1 or 2.

Use the **↵** Backspace key to switch back a menu.

## 4.9.2 LAN interface

Press the **Utility** key and turn the knob until you are in the **Port Set** menu. The **Serial** menu is active. Use the **▼** key to activate the **LAN Set** submenu.



- (1) Press the  button to start the edit mode. Set the value of IP address, Subnet Mask, Gateway and Port number. Enter numerical values via the number field and press the keys /  keys to move the cursor to the desired position. Use the /  keys to move the cursor up and down.

Use the  Backspace key to switch back a menu.

- (2) Restart the device to apply the settings.



## 4.9.3 LCD test

The device has a test function of the display. Press the **Utility** key and turn the knob until you are in the **Port Set** menu. The **Serial** menu is active. Use the **▼** key to activate the **LCD Test** submenu.

- (1) Press the key to  start the test mode.
- (2) Press the  key to change the color between red, green and blue. Check if the display has strong deviations, errors or spots.
- (3) Press the key to  exit the test mode.

## 4.9.4. keys test

The device has a test function of the push buttons. Press the **Utility** key and turn the knob until you are in the **Port Set** menu. The **Serial** menu is active. Use the **▼** key to activate the **Key Test** submenu.

- (1) Press the key to  start the test mode.
- (2) Each gray box displayed reflects one of the pushbuttons. If you press them, the gray box turns green and you can thus test the function.
- (3) Press the key to  exit the test mode.

## **5. troubleshooting**

### **1. The device has been switched on, but the display remains dark**

- Check the power supply line to the device
- Check that the mains voltage selector switch is in the correct position.
- Check whether the device fuse is still intact.
- Switch the device back on after performing the above actions.
- If the problem still exists, contact PeakTech Service.

### **2. Initial values behave in an unusual way:**

- Check whether the voltage has been set to 0V. If so, change the voltage value.
- Check whether the current has been set to 0A. If so, change the current value.
- If the timer mode has been selected, check whether one of the sequence steps is set to 0A or 0V. Change this value if necessary.
- If the problem still exists, contact PeakTech Service.

### **3. The USB storage device is not recognized correctly:**

- Check the storage medium for function with another device, e.g. a PC.
- External USB hard drives are not supported, only flash memory can be used.
- Restart the device and insert the USB storage medium again.
- If the problem still exists, contact PeakTech Service.

## 6. technical specifications

The following data is based on a device that has been switched on for at least 30 minutes under the specified ambient conditions.

|  |         | Channel 1/Channel 2                       |            | Channel 3                               |
|--|---------|---|------------|---|
| DC output specifications                         | Voltage | Normal/Parallel                           | 0 ... 30V  | 0 ... 6V                                |
|  |         | Serial                                    | 0 ... 60V  |   |
|  | Power   | Normal /Serial                            | 0 ... 6A   | 0 ... 3A                                |
|  |         | Parallel                                  | 0 ... 12A  |   |
| Grid stability                                   | CV      | $\leq 0.01\% + 3\text{mV}$                |            | $\leq 3\text{mV}$                       |
|  | CC      | $\leq 0.1\% + 3\text{mA}$                 |            | $\leq 0.1\% + 3\text{mA}$               |
| Load stability                                   | CV      | $\leq 0.01\% + 3\text{mV}$                |            | $\leq 0.1\% + 3\text{mV}$               |
|  | CC      | $\leq 0.2\% + 3\text{mA}$                 |            | $\leq 0.2\% + 3\text{mA}$               |
| Noise / Ripple<br>(20Hz...20MHz)                 | Vp-p    | $\leq 2\text{mVp-p}$                      |            | $\leq 3\text{mVp-p}$                    |
|  | CV      | $\leq 300 \mu\text{Vrms}$                 |            | $\leq 1 \text{ mVrms} / 2 \text{ mVpp}$ |
|  | CC      | $\leq 3\text{mArms}$                      |            | $\leq 1\text{mArms}$                    |
| Setting resolution                               | Voltage | 1mV                                       |            | 1mV                                     |
|  | Power   | 1mA                                       |            | 1mA                                     |
| Input accuracy<br>(25°C±5°C within<br>12 months) | Voltage | $\leq 0.03\% + 10\text{mV}$               |            | $\leq 0.03\% + 10\text{mV}$             |
|  | Power   | $\leq 0.1\% + 8\text{mA}$                 |            | $\leq 0.1\% + 5\text{mA}$               |
| Readback Resolution                              | Voltage | 1mV                                       |            | 1mV                                     |
|  | Power   | 1mA                                       |            | 1mA                                     |
| Readback Accuracy<br>(25°C±5°C)                  | Voltage | $\leq 0.03\% + 10\text{mV}$               |            | $\leq 0.03\% + 10\text{mV}$             |
|  | Power   | $\leq 0.1\% + 8\text{mA}$                 |            | $\leq 0.1\% + 5\text{mA}$               |
| <b>Display</b>                                   |         |   |            |   |
| Technology                                       |         | 4-inch color LCD (Liquid Crystal Display) |            |   |
| Resolution                                       |         | 480 (horizontal) × 320 (vertical) pixels  |            |   |
| Colors   |         | 65536 colors, TFT screen                  |            |   |
| <b>Power supply</b>                              |         |   |            |   |
| Net  |         | Vac ± 10%; AC input 50/60Hz               |            |   |
| Nominal values / fuse                            |         | 220V                                      | 250 V, F5A |   |
| <b>Other</b>                                     |         |   |            |   |
| Cooling method                                   |         | Fan cooling (speed load-dependent)        |            |   |
| Interfaces                                       |         | USB host, USB device, LAN, RS-232         |            |   |
| <b>Dimensions</b>                                |         |   |            |   |
| Dimensions                                       |         | 250mm×158mm×358mm (W*H*D)                 |            |   |
| Weight   |         | Ca.12 kg                                  |            |   |



## **7. appendix**

### **Appendix A: Accessories**

#### **Standard accessories:**

- Power cord with the power plug intended for your country
- USB data cable
- CD with "Digit Power Software" and operating instructions

### **Appendix B: Maintenance and cleaning**

#### **General maintenance**

Do not store or use the device in direct sunlight for long periods of time.

#### **Caution:**

To avoid damage to the device, do not expose it to sprays, liquids or solvents.

#### **Cleaning**

Check the condition of the device regularly according to existing environments. Clean the device as follows:

1. Use dry cloth towels to wipe dust from the device. Do not rub the outer protective layer of the LCD display.
2. Be sure to disconnect the power supply before cleaning! Use damp cloths with a mild detergent. Do not use any corrosive scouring agents to avoid permanent damage such as corrosion to the housing.



#### **Warning:**

Before switching on the device after cleaning, make absolutely sure that there are no more water residues on the device. If in doubt, place the device in a dry room for a few hours.

*All rights reserved, including those of translation, reprint and reproduction of this manual or parts thereof.*

*Reproductions of any kind (photocopy, microfilm or any other method) are allowed only with written permission of the publisher.*

*Last version at time of printing. We reserve the right to make technical changes to the device in the interests of progress.*

*We hereby confirm that all devices meet the specifications stated in our documents and are supplied calibrated at the factory. A repetition of the calibration after 1 year is recommended.*

© **PeakTech**® 09-2021 Ehr.