

版本 Rev.	日期 Date	变更文件号 ECN NO.	变更内容 Revisions	设计 By
V1.0			带LOGO	王洪松

Dimension: (Unit: mm)

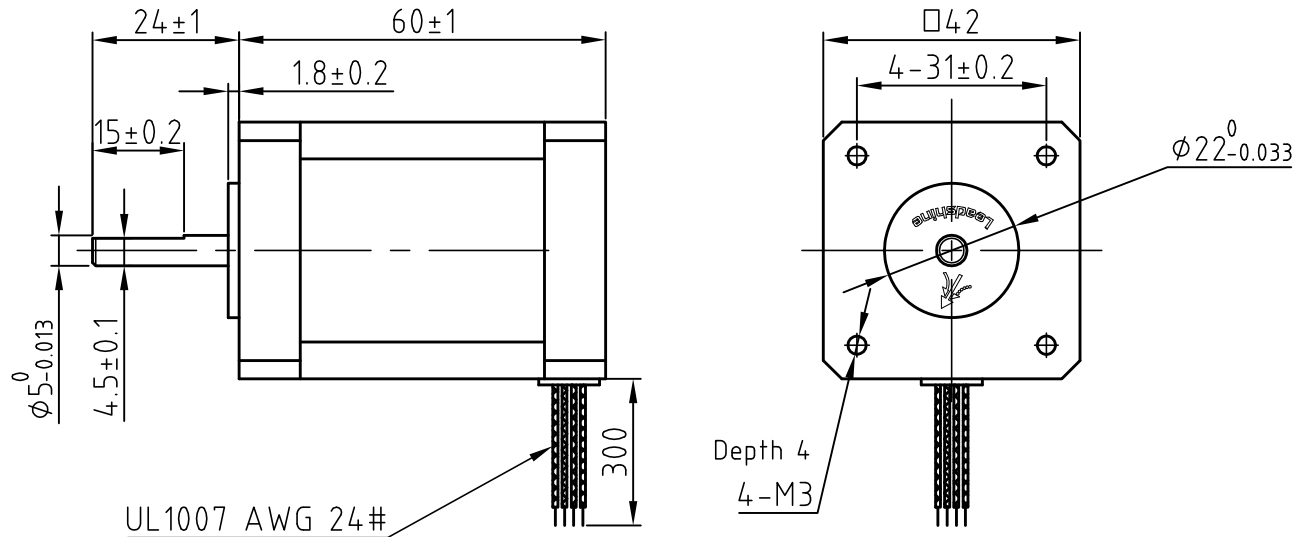

Motor Connctions:

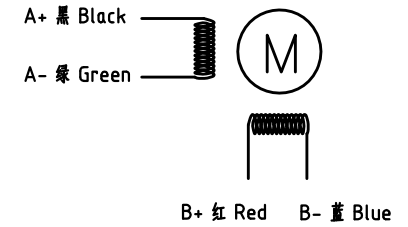

Common Rating

Step angle	1.8°
Position accuracy	1.8±0.09°
Dielectric strength	500VAC 1min
Insulation resistance	100MΩm(500VDC)
Insulation class	B
Temp rise(Max)	80K
Radial play	Max.0.02mm(Load 450g)
Axial play	Max.0.08mm(Load 900g)

Specification:

Current/phase	2.5 A
Voltage	2.5 V
DC Resistance/phase ±10%	1.0 Ω
Inductance/phase ±20%	2.4 mH
Holding torque	0.8 N·M
Inertia	0.11 kg·cm ²
Weight	0.5 kg

设计 Designed	王洪松	日期 Date	2017.06.13	材料 Material		深圳市雷赛智能控制股份有限公司 SHENZHEN LEADSHINE TECHNOLOGY CO., LTD.	
审核 Checked	刘佩峰		2017.06.13	第一角画法 First Angle projection		名称 Title	混合式步进电机
批准 Approved	田天胜		2017.06.13	重量 Weight	比例 Scale	阶段标记 Stage Mark	42CM08
料号 Part No.				共 1 张 第 1 张	Sheet 1 of 1	图号 DWG. NO.	